

36-75V Continuous Input	100V Transient Input	12V Output	204W Max Power	2250V dc Isolation	Eighth-brick DC-DC Converter
-----------------------------------	--------------------------------	----------------------	--------------------------	------------------------------	--

The BusQor® SQ60120ETA17 bus converter is a next-generation, board-mountable, isolated, fixed switching frequency dc-dc converter that uses synchronous rectification to achieve extremely high conversion efficiency. The power dissipated by the converter is so low that a heatsink is not required, which saves cost, weight, height, and application effort. The SQ BusQor series provides an isolated step down voltage from 48V to a semi-regulated 12V intermediate bus. BusQor converters are ideal for customers who need multiple outputs and wish to build or buy point of load converters to work with a 12V rail. RoHS Compliant (see last page).

BusQor®

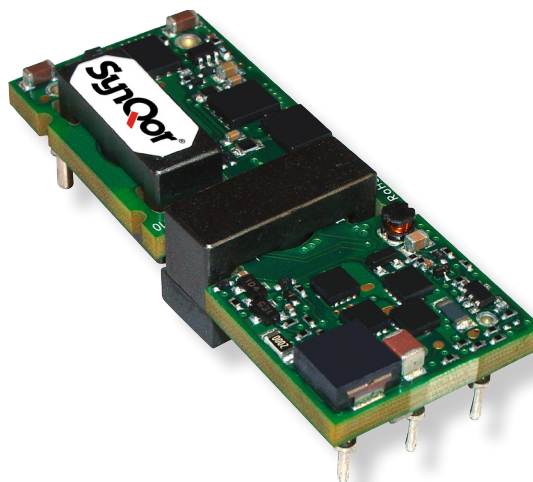

SQ60120ETA17 Model

Operational Features

- Ultra-high efficiency, 94% at full rated load current
- Delivers 17A (204W) power with minimal derating - no heatsink required
- Wide input voltage range: 36-75Vdc with 100V 100ms input voltage transient capability
- Fixed frequency switching provides predictable EMI

Mechanical Features

- Industry standard eighth-brick pin-out configuration
- Size: 0.90" x 2.3" (22.9x58.4mm), 0.498" (12.65mm)
- Total weight: 1.25 oz (35 g)

Safety Features

- CAN/CSA C22.2 No. 60950-1
- UL 60950-1
- EN 60950-1

Control Features

- On/Off control referenced to input side
- Inherent current share (by droop method) for high current and parallel applications.

Protection Features

- Input under-voltage lockout and over-voltage shutdown protects against abnormal input voltages
- Output current limit and short circuit protection
- Output over-voltage protection
- Thermal shutdown

Contents

	Page No.
Open Frame Mechanical Diagram	2
Electrical Characteristics	3
Standards & Qualifications	5
Figures	6
Application Section	10
Ordering Information	14

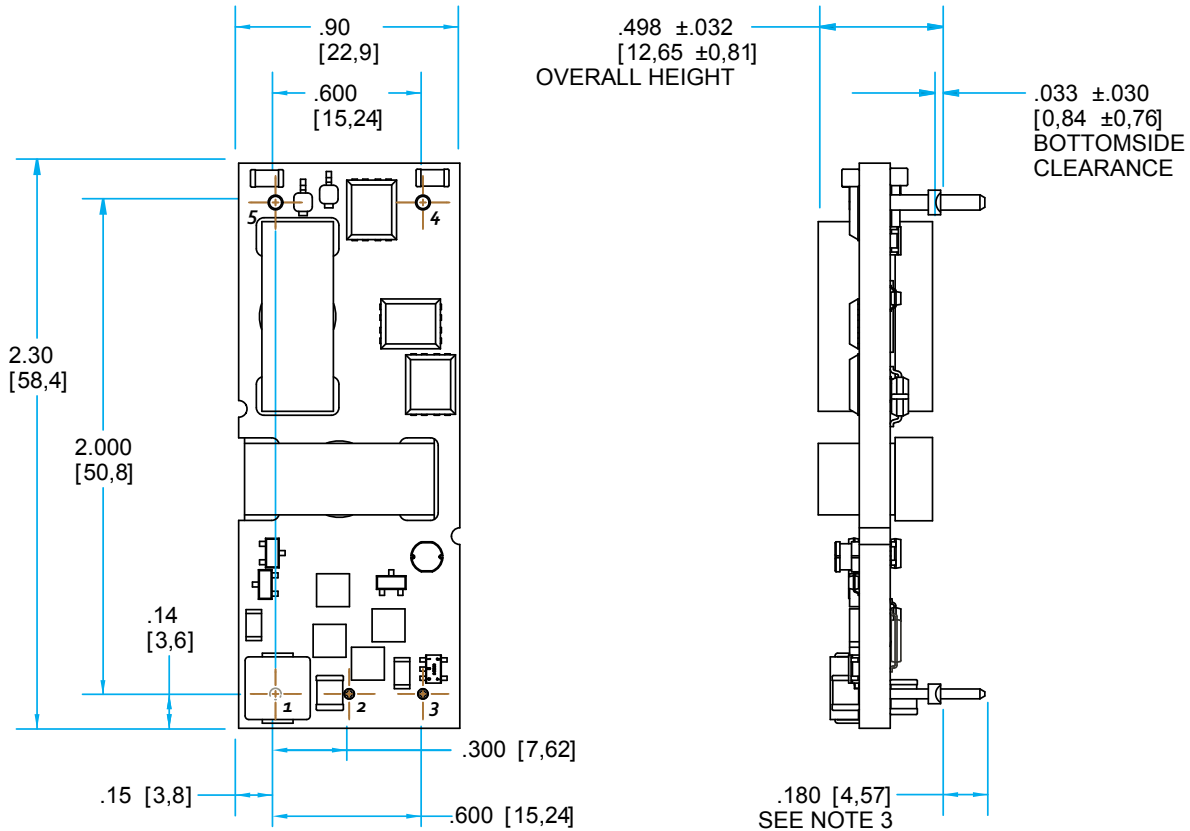

NOTES

- 1) PINS 1-3 ARE 0.040" (1.02mm) DIA. WITH 0.080" (2.03mm) DIA. STANDOFF SHOULDERS
- 2) PINS 4 & 5 ARE 0.062" (1.57mm) DIA. WITH 0.100" (2.54mm) DIA. STANDOFF SHOULDERS
- 3) OTHER PIN EXTENSION LENGTHS AVAILABLE
- 4) ALL PINS: MATERIAL: COPPER ALLOY
FINISH: MATTE TIN OVER NICKEL PLATE
- 5) UNDIMENSIONED COMPONENTS ARE SHOWN FOR VISUAL REFERENCE ONLY
- 6) ALL DIMENSIONS IN INCHES(mm)
TOLERANCES: X.XXIN +/-0.02 (X.Xmm +/-0.5mm)
X.XXXIN +/-0.010 (X.XXmm +/-0.25mm)
- 7) MAXIMUM AREA THAT THE THERMAL TRANSFER MATERIAL IS DEPOSITED
- 8) WEIGHT: 1.25 OZ (35 G) TYPICAL
- 9) WORKMANSHIP: MEETS OR EXCEEDS IPC-A-610C CLASS II
- 10) UL/TUV STANDARDS REQUIRE A CLEARANCE OF 0.04" (1.02MM) AROUND PRIMARY AREAS OF THE MODULE.

PIN DESIGNATIONS

Pin	Name	Function
1	Vin(+)	Positive Input Voltage
2	ON/OFF	TTL input to turn converter on and off, referenced to Vin (-) with internal pull up
3	Vin(-)	Negative input voltage
4	Vout(-)	Negative output voltage
5	Vout(+)	Positive output voltage

SQ60120ETA17 Electrical Characteristics

Ta = 25 °C, airflow rate = 300 LFM, Vin = 48 V dc unless otherwise noted; full operating temperature range is -40 °C to +100 °C ambient temperature with appropriate power derating. Specifications subject to change without notice.

Parameter	Min.	Typ.	Max.	Units	Notes & Conditions
ABSOLUTE MAXIMUM RATINGS					
Input Voltage					
Non-Operating	-1		100	V	Continuous
Operating	36	48	75	V	Continuous
Operating Transient Protection			100	V	100 ms transient, square wave
Isolation Voltage					
Input to Output			2250	V	
Operating Temperature	-40		100	°C	
Storage Temperature	-45		125	°C	
Voltage at ON/OFF input pin	-2		18	V	
INPUT CHARACTERISTICS					
Operating Input Voltage Range	36	48	75	V	
Input Under-Voltage Lockout					
Turn-On Voltage Threshold	31		34.5	V	
Turn-Off Voltage Threshold	27.6		32	V	
Lockout Voltage Hysteresis	2		4	V	
Input Over-Voltage Shutdown					
Turn-On Voltage Threshold		95		V	
Turn-Off Voltage Threshold		105		V	
Maximum Input Current			7.4	A	
No-Load Input Current			90	mA	
Disabled Input Current			8.5	mA	
Input Reflected-Ripple Current		6	10	mA	RMS through 10µH inductor
Input Terminal-Ripple Current		125	300	mA	RMS, full load
Recommended Input Fuse (see Note 1)			15	A	Fast blow external fuse recommended
Recommended External Input Capacitance		47		µF	Typical ESR 0.1-0.2 Ω
Input Filter Component Values (L\C)		1.0\4.4		µH\µF	Internal values
OUTPUT CHARACTERISTICS					
Output Voltage Set Point	12.46	12.5	12.54	V	Vin = 65 V, no load, Ta = 25 °C
Output Voltage Regulation					
Over Line		+0.1\ -1.2		V	
Over Load		+0\ -0.8		V	
Over Temperature		±300		mV	
Total Output Voltage Range	10.2		12.6	V	Over sample, line, load, temperature & life
Output Voltage Ripple and Noise					
Peak-to-Peak		140	180	mV	Full load
RMS		60	80	mV	Full load
Operating Output Current Range	0		17	A	Subject to thermal derating
Output DC Current-Limit Inception		22		A	Output Voltage 10% Low
Output DC Current-Limit Shutdown Voltage		7		V	
Back-Drive Current Limit while Disabled		50		mA	Negative current drawn from output
Maximum Output Capacitance			3,000	µF	Vout nominal at full load (resistive load)
DYNAMIC CHARACTERISTICS					
Output Voltage during Load Current Transient					
Step Change in Output Current (0.1 A/µs)		1300	2500	mV	50% to 75% to 50% Iout max
Settling Time		750	1200	µs	To within 1% Vout nom
Turn-On Transient					
Turn-On Time		12	17	ms	Full load, Vout=90% nom.
Start-Up Inhibit Time		200		ms	-40 °C to +125 °C; Figure E
Output Voltage Overshoot		0		%	3 mF load capacitance

SQ60120ETA17 Electrical Characteristics (continued)

Ta = 25 °C, airflow rate = 300 LFM, Vin = 48 V dc unless otherwise noted; full operating temperature range is -40 °C to +100 °C ambient temperature with appropriate power derating. Specifications subject to change without notice.

Parameter	Min.	Typ.	Max.	Units	Notes & Conditions
ISOLATION CHARACTERISTICS					
Isolation Voltage (dielectric strength)			2250	V	See Absolute Maximum Ratings
Isolation Resistance		30		MΩ	
Isolation Capacitance (input to output)		N/A		pF	See Note 4
TEMPERATURE LIMITS FOR POWER DERATING CURVES					
Semiconductor Junction Temperature			125	°C	Package rated to 150 °C
Board Temperature			125	°C	UL rated max operating temp 130 °C
Transformer Temperature			125	°C	
EFFICIENCY					
100% Load		94		%	
50% Load		94		%	
FEATURE CHARACTERISTICS					
Switching Frequency	255	300	345	kHz	
ON/OFF Control (Option P)					
Off-State Voltage	-1		0.8	V	
On-State Voltage	2.4		18	V	
ON/OFF Control (Option N)					
On-State Voltage	-1		0.8	V	
Off-State Voltage	2.4		18	V	
ON/OFF Control (Either Option)					
Pull-Up Voltage		5		V	Application notes Figure B
Pull-Up Resistance		124		kΩ	
Output Over-Voltage Protection		16		V	Over full temp range; no load
Over-Temperature Shutdown OTP Trip Point	135		145	°C	Average PCB Temperature
Over-Temperature Shutdown Restart Hysteresis		10		°C	
RELIABILITY CHARACTERISTICS					
Calculated MTBF (Telcordia) TR-NWT-000332		3.2		10 ⁶ Hrs.	80% load, 300LFM, 40 °C Ta
Calculated MTBF (MIL-217) MIL-HDBK-217F		2.9		10 ⁶ Hrs.	80% load, 300LFM, 40 °C Ta
Field Demonstrated MTBF				10 ⁶ Hrs.	See our website for details

Note 1: Safety certification tests were carried out using 15A fast blow fuse. Fuse interruption characteristics have to be taken into account while designing input traces. User should ensure that Input trace is capable of withstanding fault currents

Note 2: For applications requiring reduced output voltage ripple and noise, consult SynQor applications support (e-mail: support@synqor.com)

Note 3: For full-load to no-load transient, OVP shutdown may occur with less than 660µF external capacitance having less than 8mΩ of ESR

Note 4: Isolation capacitance can be added external to the module.



Technical Specification

Input:36-75V
Output:12V
Current:17A
Part No.:SQ60120ETA17

Standards Compliance & Qualification Testing

Parameter	Notes & Conditions
STANDARDS COMPLIANCE	
CAN/CSA C22.2 No. 60950-1	
UL 60950-1	
EN 60950-1	
Note: An external input fuse must always be used to meet these safety requirements. Contact SynQor for official safety certificates on new releases or download from the SynQor website.	

Parameter	# Units	Test Conditions
QUALIFICATION TESTING		
Life Test	32	95% rated Vin and load, units at derating point, 1000 hours
Vibration	5	10-55 Hz sweep, 0.060" total excursion, 1 min./sweep, 120 sweeps for 3 axis
Mechanical Shock	5	100 g minimum, 2 drops in x, y and z axis
Temperature Cycling	10	-40 °C to 100 °C, unit temp. ramp 15 °C/min., 500 cycles
Power/Thermal Cycling	5	Toperating = min to max, Vin = min to max, full load, 100 cycles
Design Marginality	5	Tmin-10 °C to Tmax+10 °C, 5 °C steps, Vin = min to max, 0-105% load
Humidity	5	85 °C, 85% RH, 1000 hours, continuous Vin applied except 5 min/day
Solderability	15 pins	MIL-STD-883, method 2003

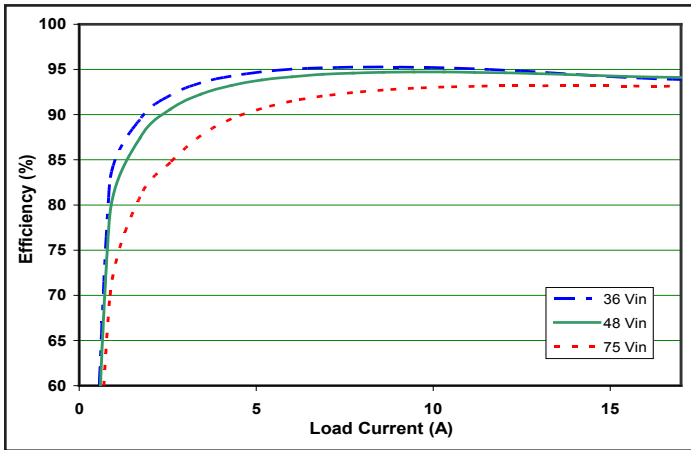

Figure 1: Efficiency at nominal output voltage vs. load current for minimum, nominal, and maximum input voltage at 25°C.

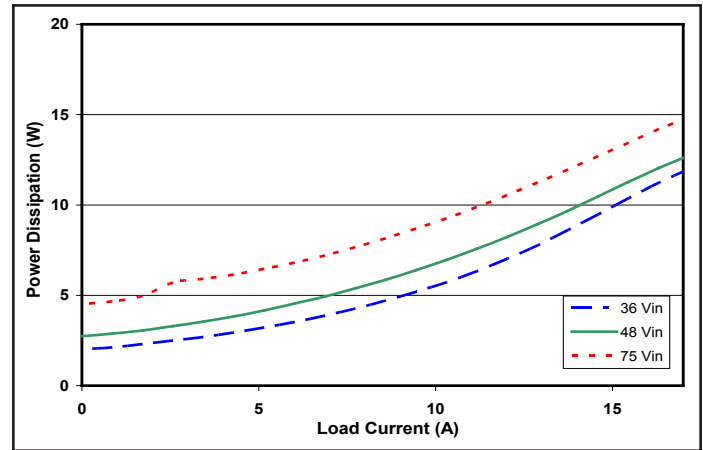

Figure 2: Power dissipation at nominal output voltage vs. load current for minimum, nominal, and maximum input voltage at 25°C.

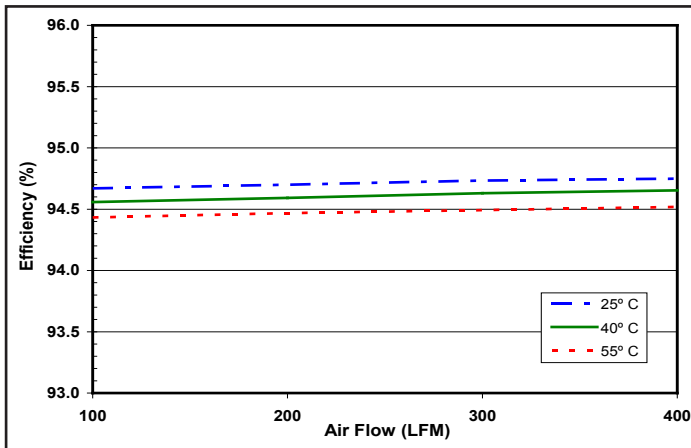

Figure 3: Efficiency at nominal output voltage and 60% rated power vs. airflow rate for ambient air temperatures of 25°C, 40°C, and 55°C (nominal input voltage).

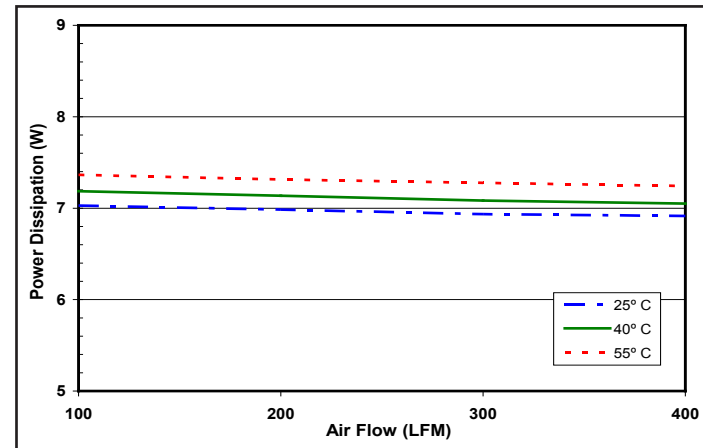

Figure 4: Power dissipation at nominal output voltage and 60% rated power vs. airflow rate for ambient air temperatures of 25°C, 40°C, and 55°C (nominal input voltage).

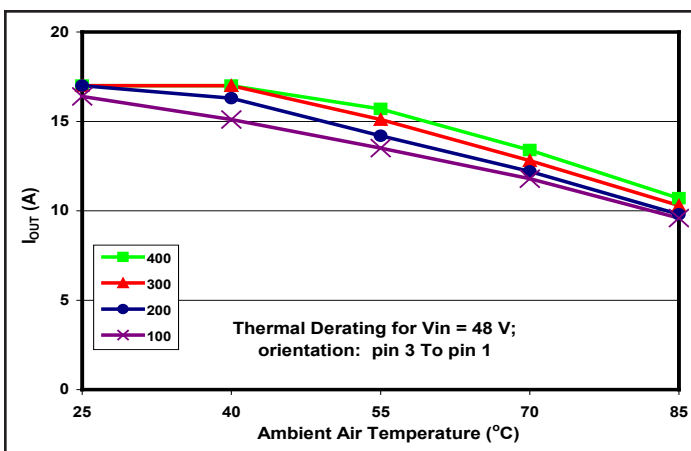

Figure 5: Maximum output power-derating curve vs. ambient air temperature for airflow rates of 100 LFM through 400 LFM with air flowing from pin 3 to pin 1 (nominal input voltage).

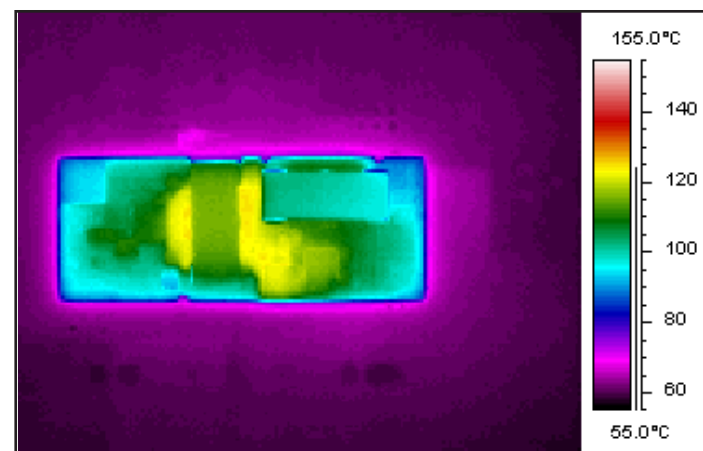

Figure 6: Thermal plot of converter at 14.2 A load current (maximum 125°C derating current) with 55°C air flowing at the rate of 200 LFM. Air is flowing across the converter from pin 3 to pin 1 (nominal input voltage).

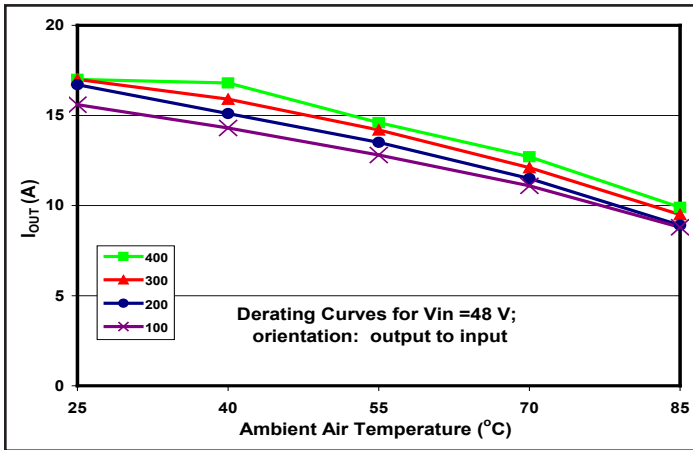

Figure 7: Maximum output power derating curves vs. ambient air temperature for airflow rates of 100 LFM through 400 LFM with air flowing across the converter from output to input (nominal input voltage).

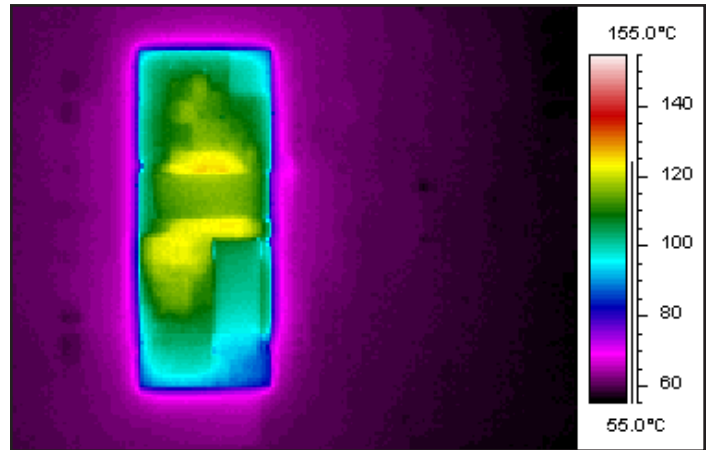

Figure 8: Thermal plot of converter at 13.5 A load current (max 125°C derating current) with 55°C air flowing at the rate of 200 LFM. Air is flowing across the converter from output to input (nominal input voltage).

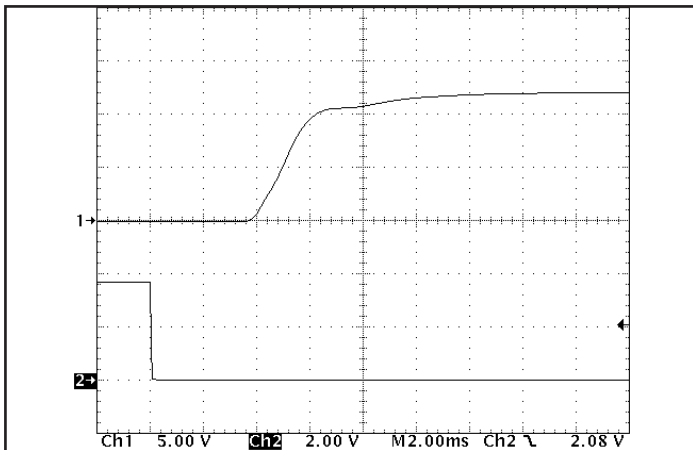

Figure 9: Turn-on transient at half load (resistive load) (2.0 ms/div). Load cap: 3 mF output capacitance. Input voltage pre-applied. Ch 1: V_{out} (5 V/div), Ch 2: ON/OFF input (2 V/div). V_{in} = 48V.

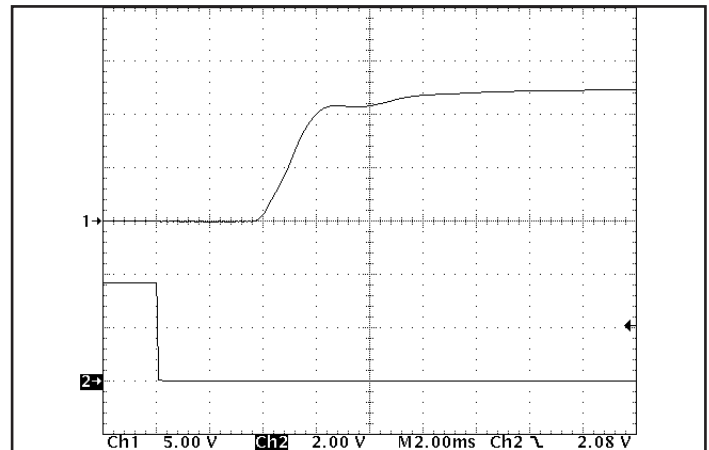

Figure 10: Turn-on transient at zero load (2.0 ms/div). Load cap: 3 mF output capacitance. Input voltage pre-applied. Ch 1: V_{out} (5 V/div), Ch 2: ON/OFF input (2 V/div). V_{in} = 48V.

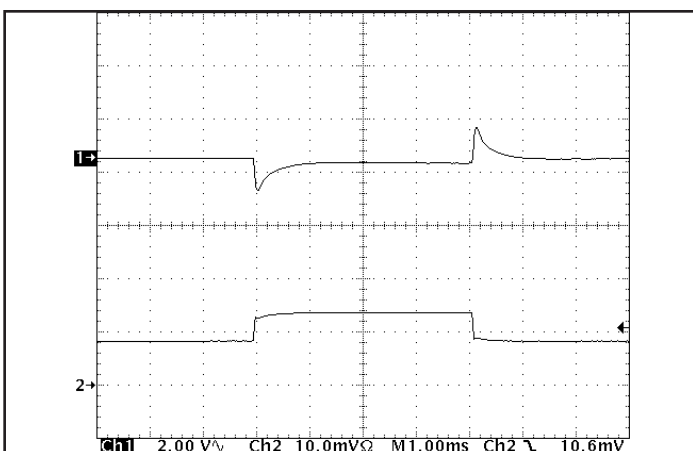

Figure 11: Output voltage response to step-change in load current (50%-75%-50% of I_{out}(max); di/dt = 0.1A/μs). Load cap: 100μF, 100 mΩ ESR tantalum cap and 1μF ceramic cap. Ch 1: V_{out} (2 V/div), Ch 2: I_{out} (10A/div). V_{in} = 48V

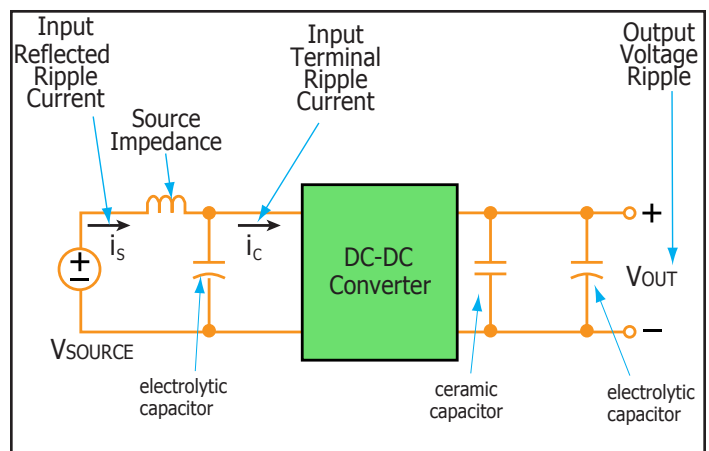

Figure 12: Test set-up diagram showing measurement points for Input Terminal Ripple Current (Figure 13), Input Reflected Ripple current (Figure 14) and Output Voltage Ripple (Figure 15).

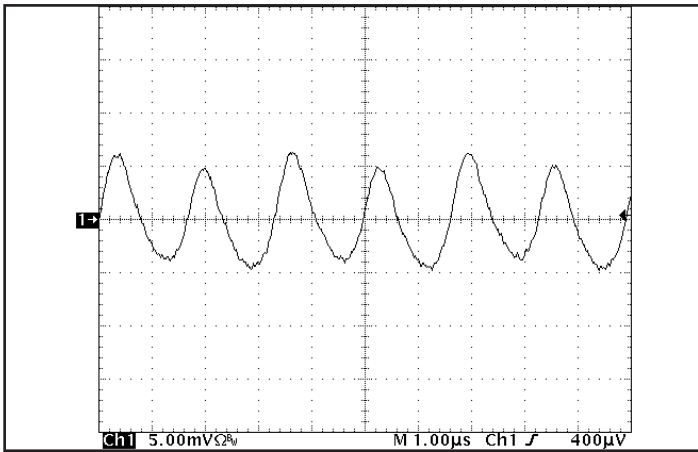

Figure 13: Input Terminal Ripple Current, i_c , at full rated output current and nominal input voltage with $10\ \mu\text{H}$ source impedance and $47\ \mu\text{F}$ electrolytic capacitor ($200\ \text{mA/div}$). See Figure 12.

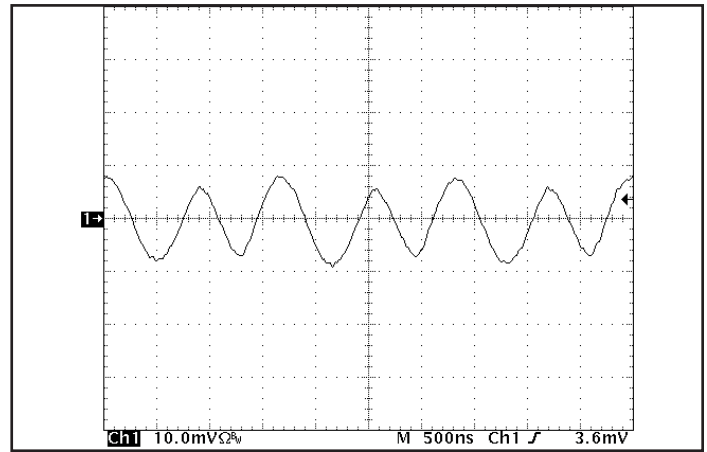

Figure 14: Input reflected ripple current, i_s , through a $10\ \mu\text{H}$ source inductor at nominal input voltage and rated load current ($10\ \text{mA/div}$). See Figure 12.

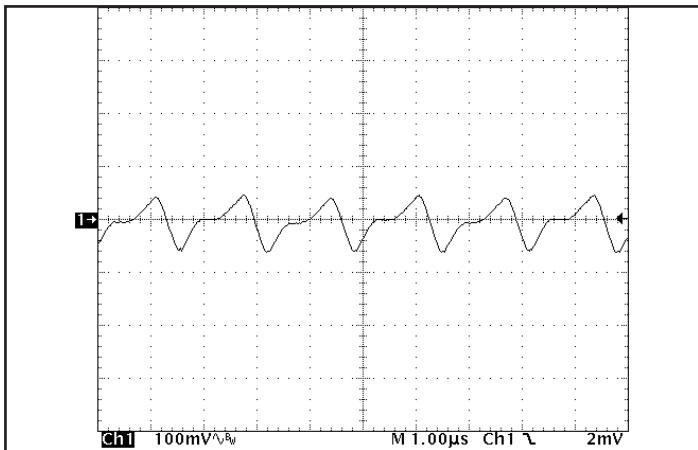

Figure 15: Output voltage ripple at nominal input voltage and rated load current ($100\ \text{mV/div}$). Load capacitance: $1\ \mu\text{F}$ ceramic capacitor and $15\ \mu\text{F}$ tantalum capacitor. Bandwidth: $20\ \text{MHz}$. See Figure 12.

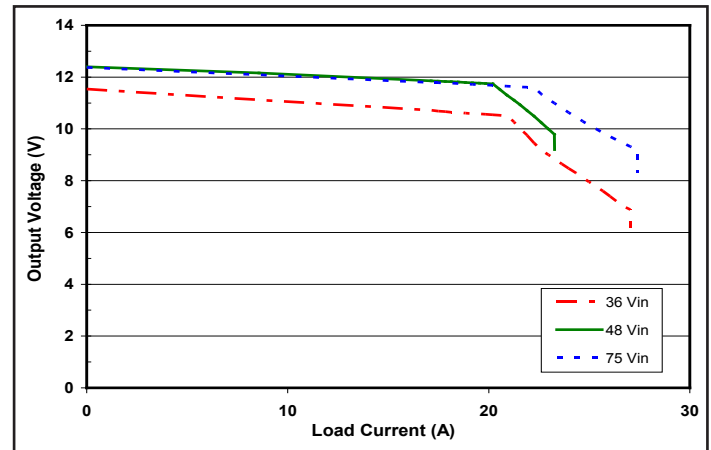

Figure 16: Output voltage vs. load current showing typical current limit curves and converter shutdown points.

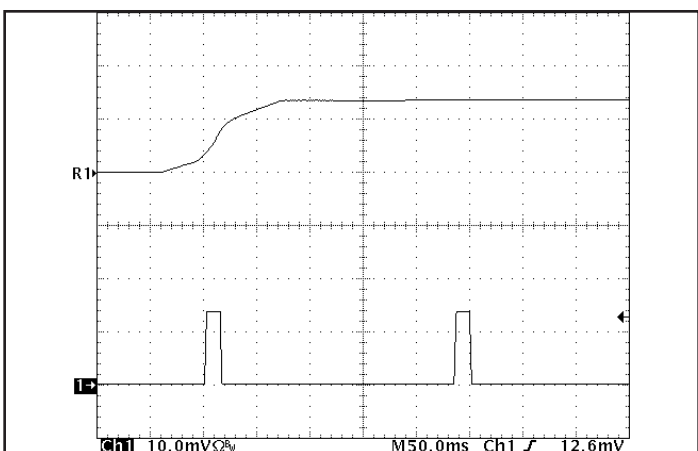

Figure 17: Load current ($50\ \text{A/div}$) as a function of time when the converter attempts to turn on into a $1\ \text{m}\Omega$ short circuit. Top trace ($500\ \mu\text{s/div}$) is an expansion of the on-time portion of the bottom trace. $V_{in} = 48\ \text{V}$

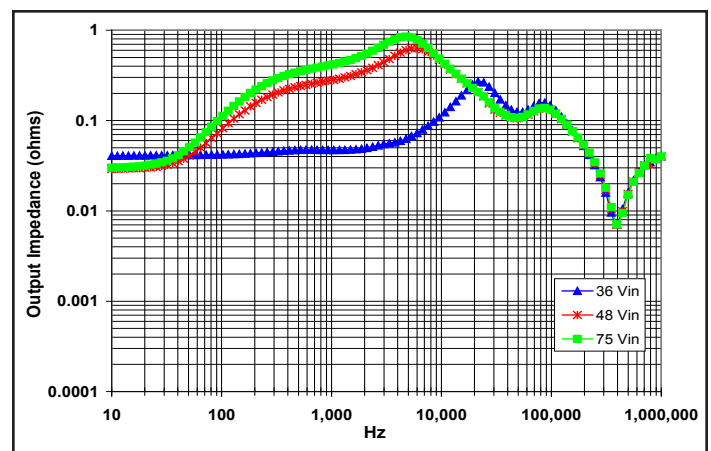

Figure 18: Magnitude of incremental output impedance ($Z_{out} = V_{out}/I_{out}$) for minimum, nominal, and maximum input voltage at full rated power.

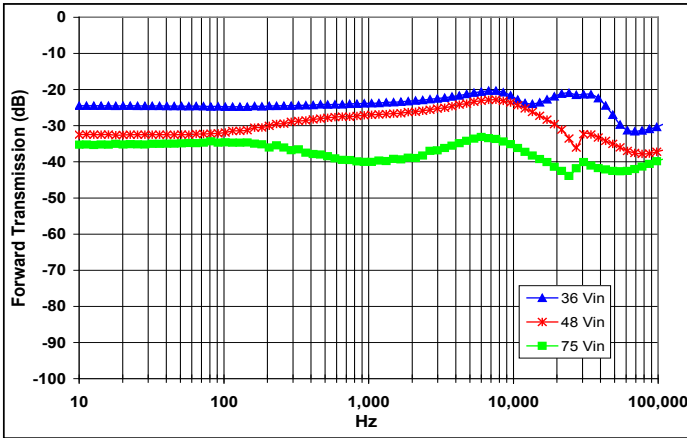

Figure 19: Magnitude of incremental forward transmission ($FT = V_{out}/V_{in}$) for minimum, nominal, and maximum input voltage at full rated power.

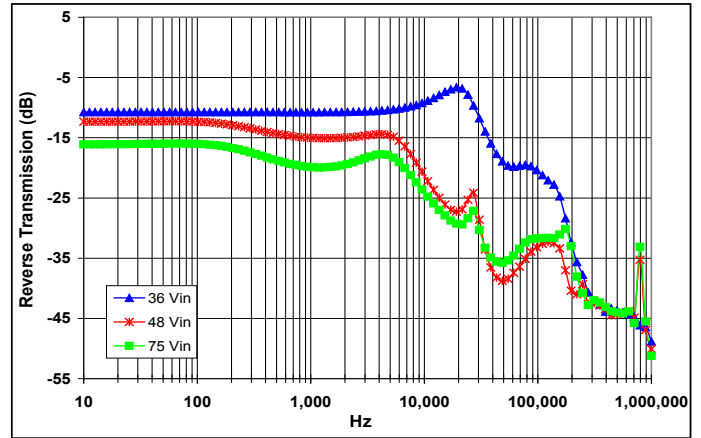

Figure 20: Magnitude of incremental reverse transmission ($RT = I_{in}/I_{out}$) for minimum, nominal, and maximum input voltage at full rated power.

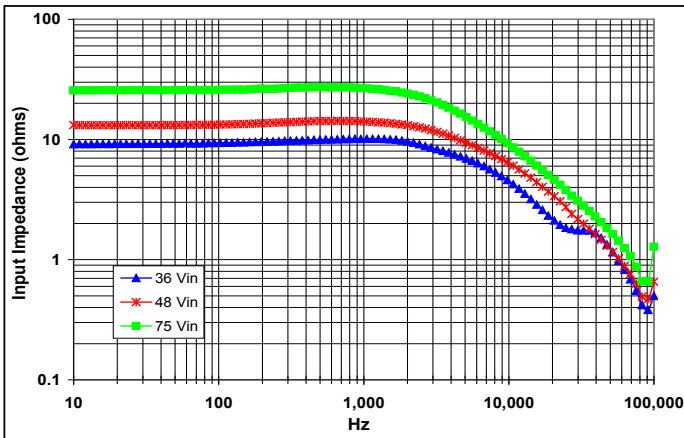

Figure 21: Magnitude of incremental input impedance ($Z_{in} = V_{in}/I_{in}$) for minimum, nominal, and maximum input voltage at full rated power.

BASIC OPERATION AND FEATURES

With voltages dropping and currents rising, the economics of an Intermediate Bus Architecture (IBA) are becoming more attractive, especially in systems requiring multiple low voltages. IBA systems separate the role of isolation and voltage scaling from regulation and sensing. The BusQor series bus converter provides isolation and a coarse voltage step down in one compact module, leaving regulation to simpler, less expensive non-isolated converters.

In Figure A below, the BusQor module provides the isolation stage of the IBA system. The isolated bus then distributes power to the non-isolated buck regulators to generate the required voltage levels at the point of load. In this case, the bucks are represented with SynQor's NiQor series of non-isolated dc-dc converters. In many applications requiring multiple low voltage outputs, significant savings can be achieved in board space and overall system costs.

When designing an IBA system with bus converters, the designer can select from a variety of bus voltages. While there is no universally ideal bus voltage, most designs employ one of the following: 12V, 9V, 7.5V, 5V, or 3.3V. Higher bus voltages can lead to lower efficiency for the buck regulators but are more efficient for the bus converter and provide lower board level distribution current. Lower bus voltages offer the opposite trade offs.

SynQor's SQ BusQor modules accept the full 48/60V telecom bus voltage and have a narrow output voltage range compatible with many non-isolated point of load converters. When used in IBA systems, the output variation of the BusQor must be in accordance with the input voltage range of the non-isolated converters being employed.

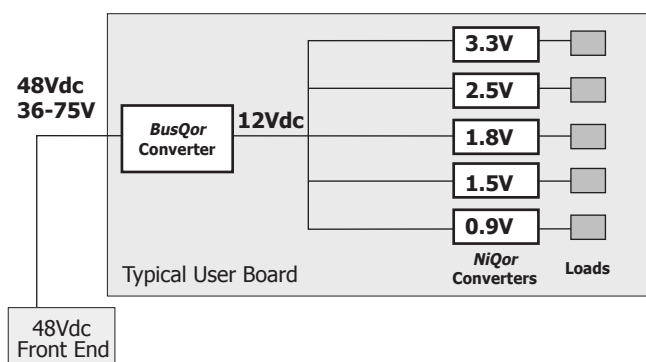

Figure A: Example of Intermediate Bus Architecture using BusQor bus converter and NiQor non-isolated converters

CONTROL FEATURES

REMOTE ON/OFF (Pin 2): The ON/OFF input, Pin 2, permits the user to control when the converter is on or off. This input is referenced to the return terminal of the input bus, Vin(-). There are two versions of the converter that differ by the sense of the logic used for the ON/OFF input.

In the positive logic version, the ON/OFF input is active high (meaning that a high turns the converter on). In the negative logic version, the ON/OFF signal is active low (meaning that a low turns the converter on). Figure B is a detailed look of the internal ON/OFF circuitry.

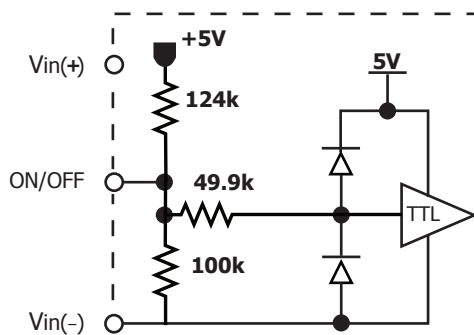

Figure B: Internal ON/OFF pin circuitry

Protection Features

Input Under-Voltage Lockout: The converter is designed to turn off when the input voltage is too low, helping avoid an input system instability problem, described in more detail in the application note titled "Input System Instability" available on www.SynQor.com. The lockout circuitry is a comparator with DC hysteresis. When the input voltage is rising, it must exceed the typical Turn-On Voltage Threshold value (listed on the specification page) before the converter will turn on. Once the converter is on, the input voltage must fall below the typical Turn-Off Voltage Threshold value before the converter will turn off. Also see figure E.

Output Current Limit: The output of the BusQor module is electronically protected against output overloads. When an overload current greater than the "DC Current-Limit Inception" specification is drawn from the output, the output of the BusQor will shutdown to zero volts after the 1 ms have elapsed (see Figure C). The shutdown period lasts for a typical period of 200ms (Figure D) after which the BusQor tries to power up again. If the overload persists, the output voltage will go through repeated cycles of shutdown and restart with a duty cycle of 20ms (On) and 200 ms (Off) respectively. The BusQor module returns (auto resetting) to normal operation once the overload is removed. The BusQor is designed to survive in this mode indefinitely without damage and without human intervention.

Output Short Circuit Protection: When the output of the BusQor module is shorted, a peak current of typically 65A will flow into the short circuit for a time of about 20ms. The output of the BusQor will shutdown to zero volts after the 20ms have elapsed (Figure D). The shutdown period lasts for a time of 200ms, at the end of which the BusQor module tries to power up again. If the short circuit persists, the output voltage will go through repeated cycles of shutdown and restart with a duty cycle of 20ms (On) and 200ms (Off) respectively. The BusQor module returns (auto resetting) to normal operation once the short circuit is removed. The BusQor is designed to survive in this mode indefinitely without damage and without human intervention.

In the Auto resetting mode, also referred to as "Hiccup" mode, the power drawn from the 48 V input is about 5 Watts, most of which is dissipated into the external fault. It is important that copper traces and pads from the output circuit be designed to withstand the short term peaks, although the average current into the fault may be as low as 50 mA typical. See Figure 17 for appropriate waveform.

Over-Temperature Shutdown: A temperature sensor on the converter senses the average temperature of the module. The thermal shutdown circuit is designed to turn the converter off when the temperature at the sensed location reaches the Over-Temperature Shutdown value. It will allow the converter to turn on again when the temperature of the sensed location falls by the amount of the Over-Temperature Shutdown Restart Hysteresis value.

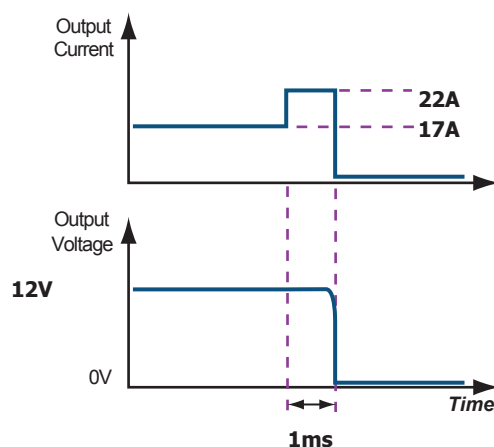

Figure C: Output Overload protection diagram (not to scale)

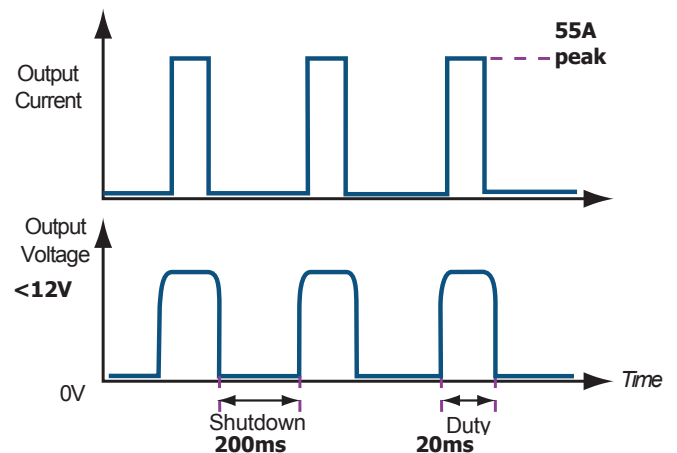

Figure D: Output Short Circuit and Auto-Resetting protection diagram (not to scale)

APPLICATION CONSIDERATIONS

Startup Inhibit Period: Figure E details the Start-Up Inhibit Period for the BusQor module when V_{in} is applied with the On/Off pin asserted (enabled). Before time t_1 , when the input voltage Off pin asserted (enabled). Before time t_1 , when the input voltage is below the UVL threshold, the unit is disabled by the Input Under-Voltage Lockout feature. When the input voltage rises above the UVL threshold, the Input Under-Voltage Lockout is released, and a typical Startup Inhibit Period of 8ms from a V_{in} start-up. Once the module recognizes it should be on it waits an additional 4ms before it starts. When starting from an on/off event the module has an inhibit time of 200ms like our standard products. The output builds up to 90% or higher of the nominal voltage and stabilizes to its nominal output voltage in a total time of 15ms typical.

At time t_2 , when the On/Off pin is de-asserted (disabled), the BusQor module stops switching immediately. Fall time from 12V to 0V is dependent on output capacitance load current, and any parasitic trace inductance in the output load circuit.

At time t_3 , when the On/Off pin is re-asserted (enabled), the BusQor module output begins to build up after the inhibit period of 200ms typical.

Refer to the Control Features section of the data sheet for details on enabling and disabling methods for N and P logic type modules.

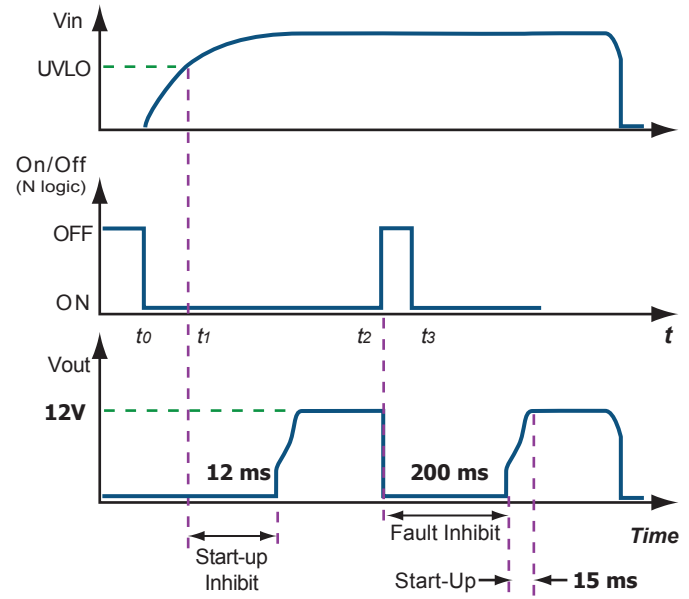

Figure E: Power Up/Down Diagram (not to scale) showing Start-Up Inhibit Period.

Droop Current Sharing:

This product has primary side regulation only. Primary side regulation results in a voltage droop as the load current increase (droop characteristic). The inherent impedance of the power stage due to its droop characteristic can be used to balance the load current between multiple modules that are placed in parallel. The graphs in this section show two units by way of example, but there is no fundamental limit to the number of units that can be placed in parallel.

When multiple units having droop characteristics are placed in parallel, the current sharing accuracy is determined by the output voltage set point accuracy relative to the total output voltage droop for a given load current range. A difference in voltage between two units will cause a differential current to flow out of one unit and into the other. Figure F shows an example with two units with an output voltage mismatched by 0.5%. In this example, when Unit A is at 100% of its full rated load current, Unit B is only at 90%, effectively reducing the total available current by 5%. SynQor uses factory calibration of each unit to ensure that output voltage is well matched.

Temperature Mismatch Self Balancing: the slope of the output voltage droop characteristic of semi regulated module increases with increased temperature. Therefore, if a paralleled unit were hotter than its neighbor because it is supplying more load current, then its output voltage will droop further forcing the cooler module(s) to increase its load current. The increase in effective output resistance due to an increase in temperature acts as a self correcting mechanism (Figure G) when two or more modules are connected in a parallel configuration.

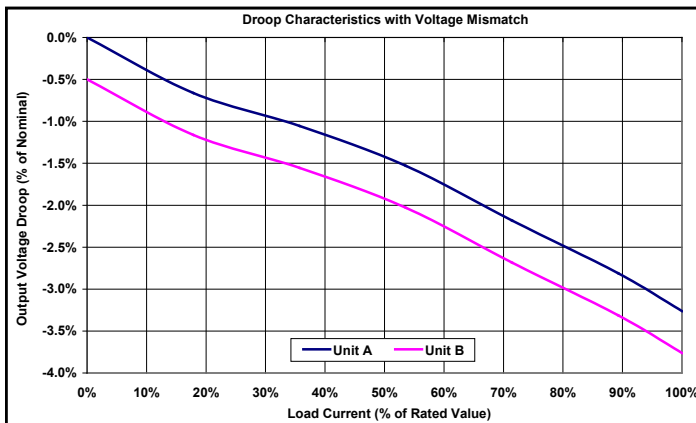

Figure F: Example of Droop Characteristic with Output Voltage Mismatch.

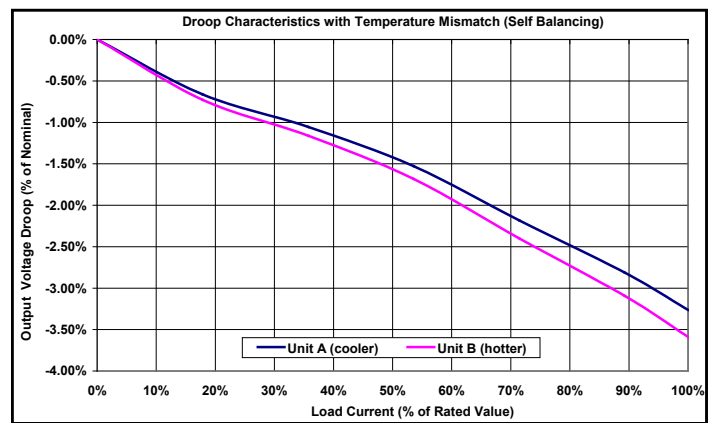

Figure G: Droop Characteristic with Temperature Mismatch (self balancing)



Ordering Information

Input:36-75V
Output:12V
Current:17A
Part No.:SQ60120ETA17

Part Numbering System

The part numbering system for SynQor's dc-dc converters follows the format shown in the example below.

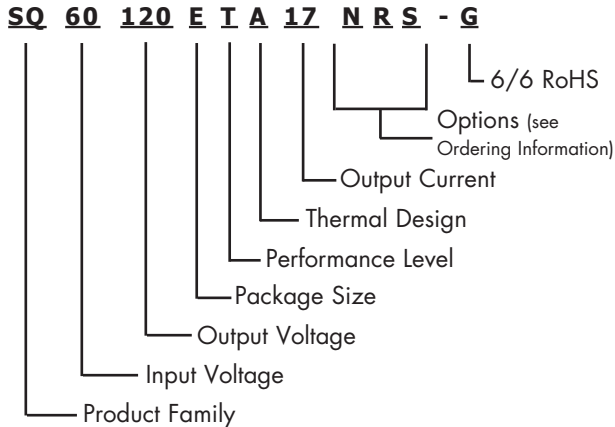

The first 12 characters comprise the base part number and the last 3 characters indicate available options. The "-G" suffix indicates 6/6 RoHS compliance.

Application Notes

A variety of application notes and technical white papers can be downloaded in pdf format from our [website](#).

RoHS Compliance: The EU led RoHS (Restriction of Hazardous Substances) Directive bans the use of Lead, Cadmium, Hexavalent Chromium, Mercury, Polybrominated Biphenyls (PBB), and Polybrominated Diphenyl Ether (PBDE) in Electrical and Electronic Equipment. This SynQor product is 6/6 RoHS compliant. For more information please refer to SynQor's RoHS addendum available at our [RoHS Compliance / Lead Free Initiative web page](#) or e-mail us at rohs@synqor.com.

Contact SynQor for further information and to order:

Phone: 978-849-0600 Toll Free: 888-567-9596 Fax: 978-849-0602

E-mail: power@synqor.com Web: www.synqor.com

Address: 155 Swanson Road, Boxborough, MA 01719 USA

Warranty

SynQor offers a three (3) year limited warranty. Complete warranty information is listed on our website or is available upon request from SynQor.

Ordering Information

The tables below show the valid model numbers and ordering options for converters in this product family. When ordering SynQor converters, please ensure that you use the complete 15 character part number consisting of the 12 character base part number and the additional characters for options. Add "-G" to the model number for 6/6 RoHS compliance.

Model Number	Input Voltage	Output Voltage	Max Output Current
SQ60120ETA17xyz-G	36-75V	12V	17A

The following options must be included in place of the **wxyz** spaces in the model numbers listed above.

Options Description:			
Thermal Design	Enable Logic	Pin Style	Feature Set
A - Open Frame	N - Negative P - Positive	K - 0.110" N - 0.145" R - 0.180" Y - 0.250"	S - Standard

Not all combinations make valid part numbers, please contact SynQor for availability.

PATENTS

SynQor holds numerous U.S. patents, one or more of which apply to most of its power conversion products. Any that apply to the product(s) listed in this document are identified by markings on the product(s) or on internal components of the product(s) in accordance with U.S. patent laws. SynQor's patents include the following:

7,050,309 7,765,687 7,787,261

8,149,597 8,644,027